

THIS DRAWING IS UNPUBLISHED. RELEASED FOR PUBLICATION
 © COPYRIGHT - ALL RIGHTS RESERVED.

LOC		DIST		REVISIONS			DATE	DWN	APVD
J				P	LTR	DESCRIPTION			
				E		REVISED PER-ECR-20-011859	21AUG2020	M. J	E. I

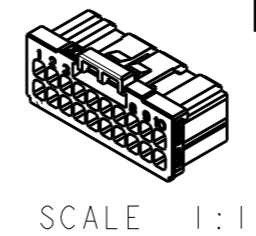

- 1. MATERIAL: GLASS FILLED THERMO PLASTIC POLYESTER(94V-0), COLOR: BLACK
- 2. THE SHAPE, SIZE AND POSITION OF THE CHARACTER SHOW THE OUTLINE. THEY DON'T SHOW DETAILS.
- 3. THE KEYING ARRANGEMENT OF "Y" IS SYMMETRIC WITH "X".

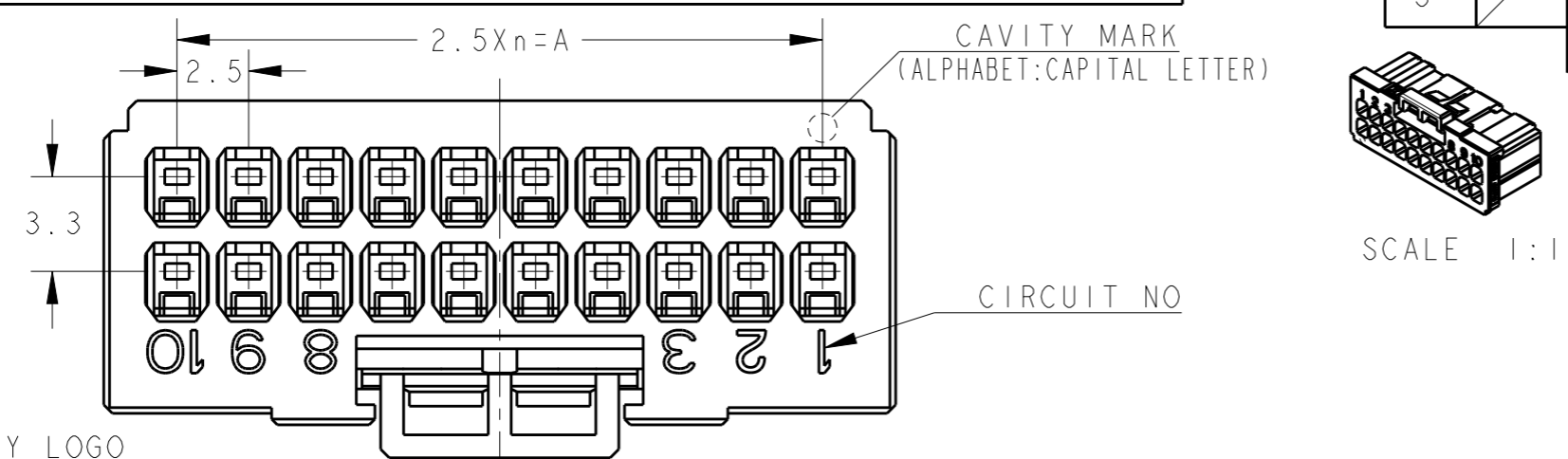
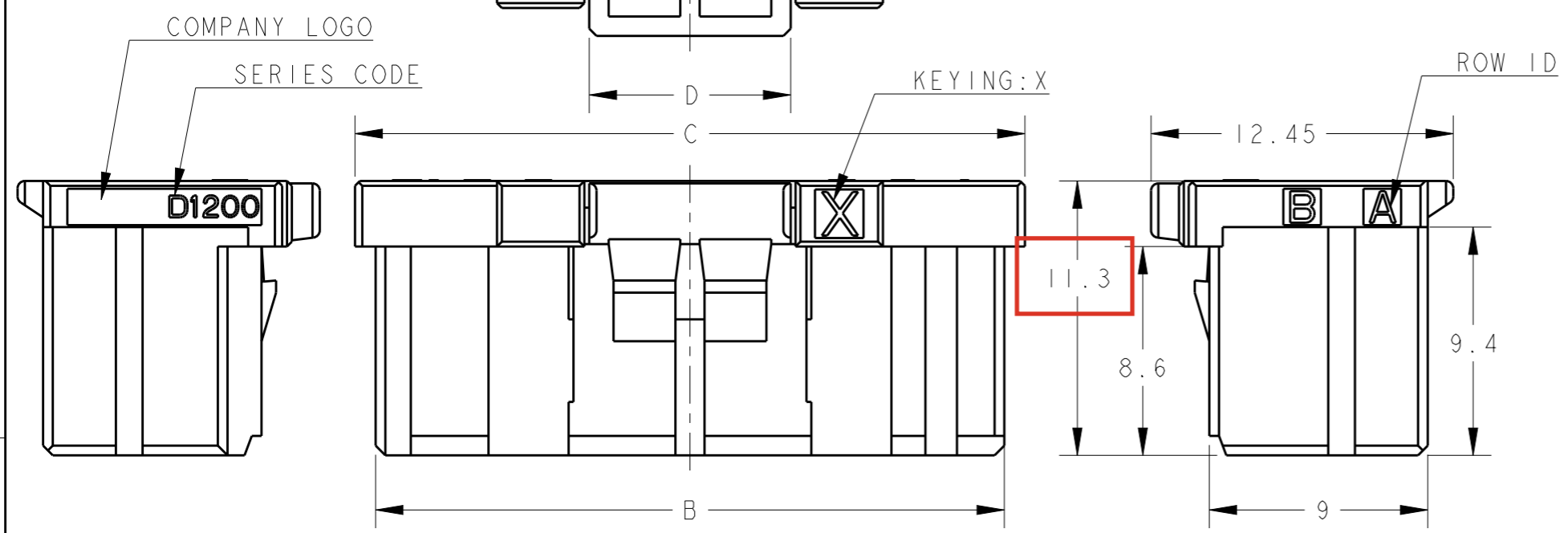

- 4. DIFFERENT HEIGHT OF LOCK PROTECTOR. A FINGERTIP IS STOOD AND PUSHED WHEN OPERATING A LOCK LEVER.
- 1. 材料: ガラス入り熱可塑性ポリエステル樹脂(94V-0), 色: 黒
- 2. 文字の形状、大きさ、および位置については、大略を示すものであり、詳細を示すものではありません。
- 3. Y KEY形状は、X KEY形状と左右対称

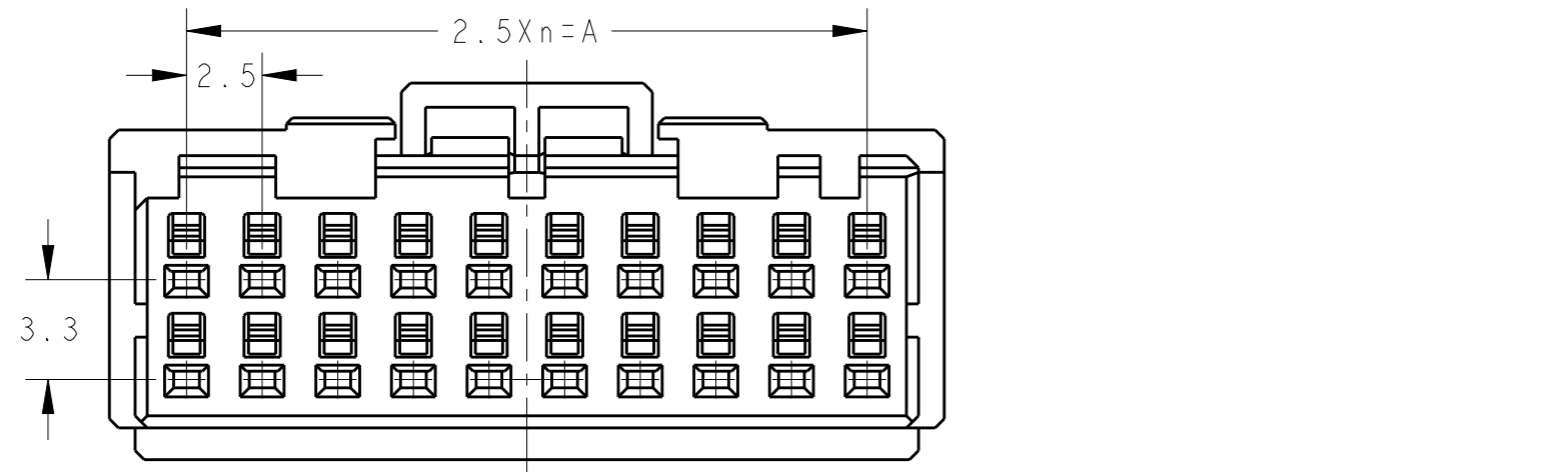

4. LOCK PROTECTORの高さ違いです。
 ロックレバー操作の際には、指先を立てて押してください。

20	Y	9	22.5	25.9	27.6	8.3	2-1827864-0
20	X	9	22.5	25.9	27.6	8.3	1-1827864-0
16	Y	7	17.5	20.9	22.6	8.3	2-1827864-8
16	X	7	17.5	20.9	22.6	8.3	1-1827864-8
12	Y	5	12.5	15.9	17.6	8.3	2-1827864-6
12	X	5	12.5	15.9	17.6	8.3	1-1827864-6
12	X	5	12.5	15.9	17.6	8.3	9-1827864-6
10	Y	4	10.0	13.4	15.1	3.3	2-1827864-5
10	X	4	10.0	13.4	15.1	3.3	1-1827864-5
8	Y	3	7.5	10.9	12.6	3.3	2-1827864-4
8	X	3	7.5	10.9	12.6	3.3	1-1827864-4
6	Y	2	5.0	8.4	10.1	3.3	2-1827864-3
6	X	2	5.0	8.4	10.1	3.3	1-1827864-3
6	X	2	5.0	8.4	10.1	3.3	9-1827864-3
4	Y	1	2.5	5.9	7.6	3.1	2-1827864-2
4	X	1	2.5	5.9	7.6	3.1	1-1827864-2
4	X	1	2.5	5.9	7.6	3.1	9-1827864-2
POS	KEY	n	A	B	C	D	PART NO

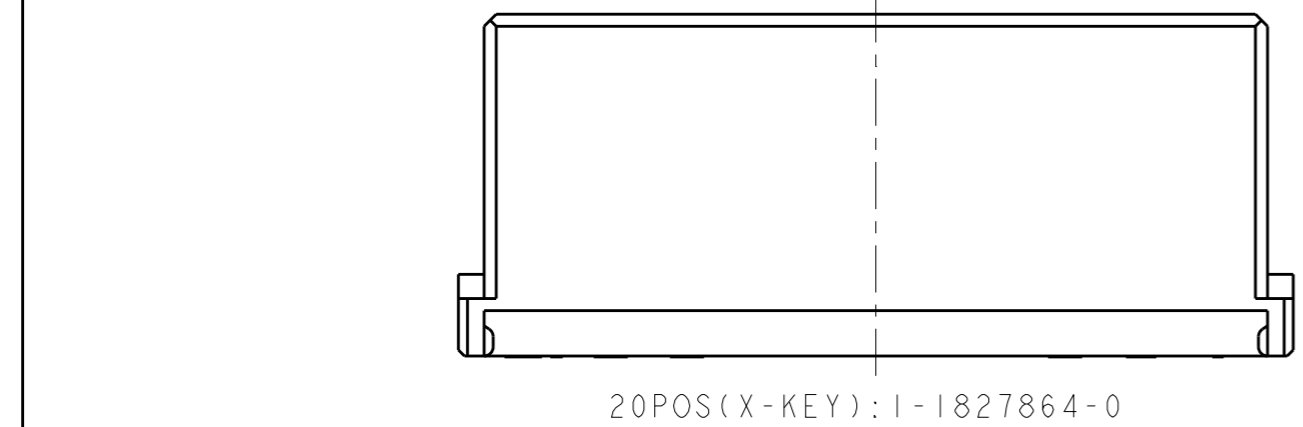

THIS DRAWING IS A CONTROLLED DOCUMENT.

DIMENSIONS: 単位: 耗 mm	TOLERANCES UNLESS OTHERWISE SPECIFIED: 一般公差 ±0.3, ±5°	DWN T. KUDO 23AUG2005	 TE Connectivity
	0 PLC ±	CHK D. MITSUGI 23AUG2005	
	1 PLC ±	APVD D. MITSUGI 23AUG2005	
	2 PLC ±	PRODUCT SPEC 製品規格 108-78268, 78298	
MATERIAL 材料	FINISH 仕上	APPLICATION SPEC 取付適用規格 114-5377	NAME 名称 DYNAMIC D1200D 2.5mm PITCH REC HSG 4-20 POS
		WEIGHT	SIZE A3 CAGE CODE 00779 DRAWING NO C-1827864 RESTRICTED TO
		CUSTOMER DRAWING	SCALE 尺度 4:1 SHEET 1 OF 4 REV E

THIS DRAWING IS UNPUBLISHED.

RELEASED FOR PUBLICATION

ALL RIGHTS RESERVED.

© COPYRIGHT -

LOC J DIST

P

LTR

SEE SHEET 1

REVISIONS

變更

DESCRIPTION

DATE

DWN

APVD

CAVITY MARK ONLY 4POS

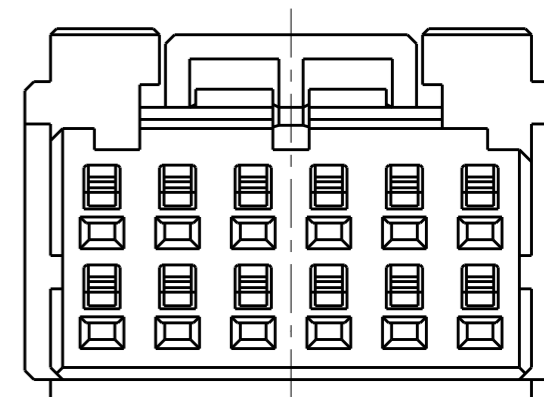
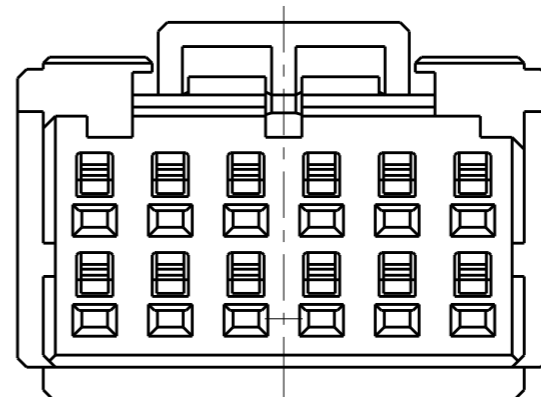
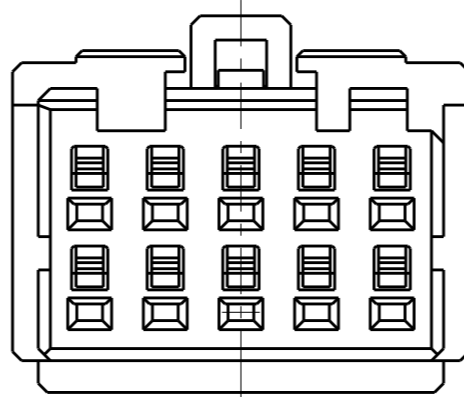
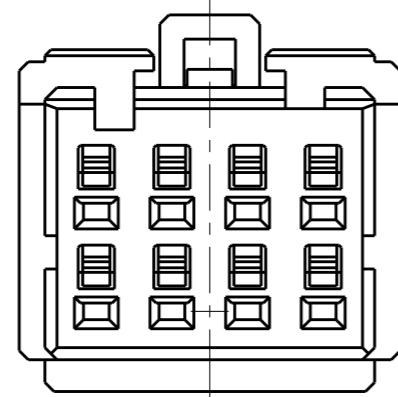
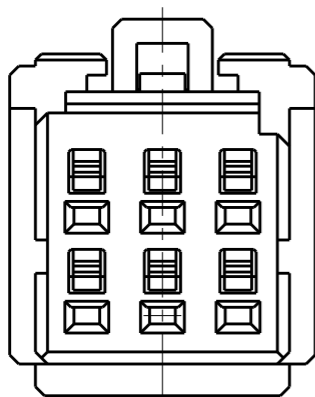
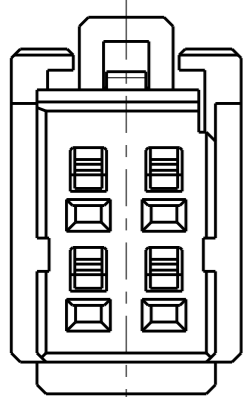
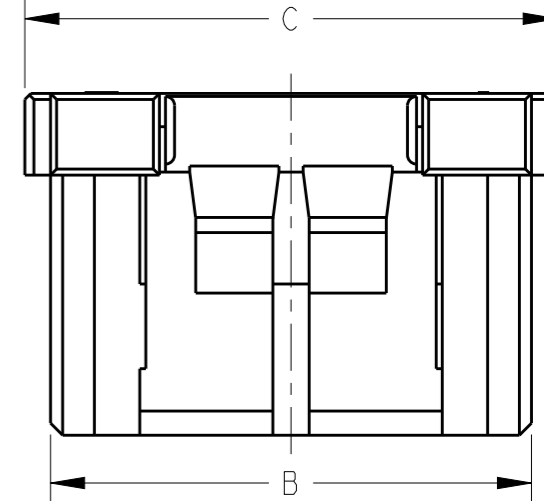
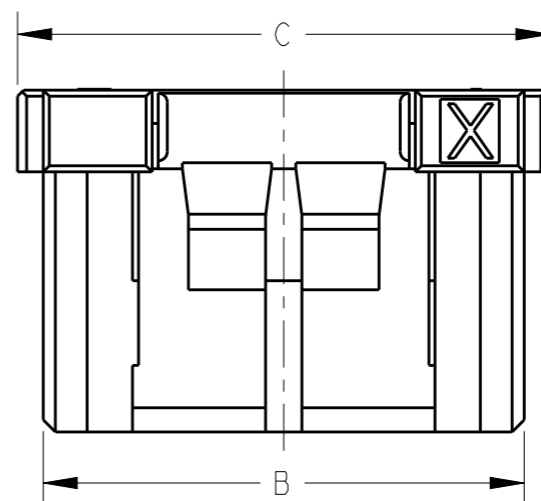
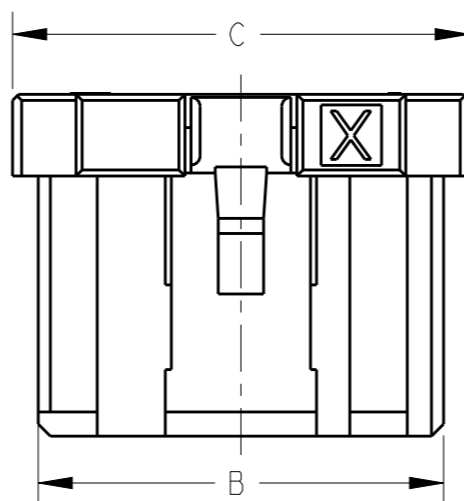
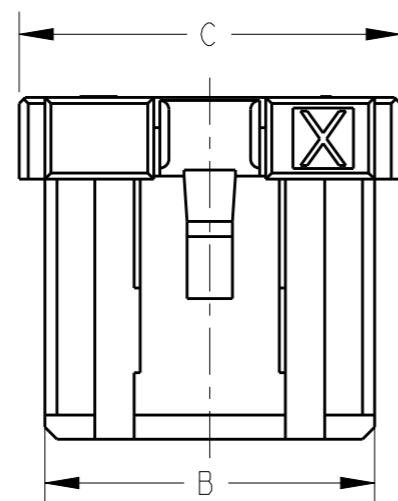
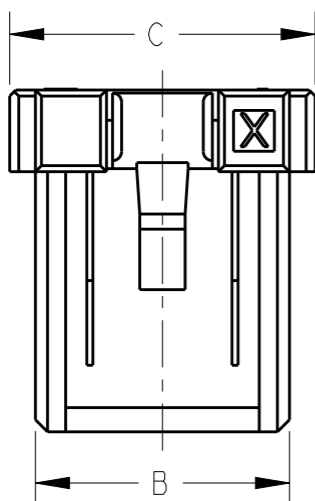
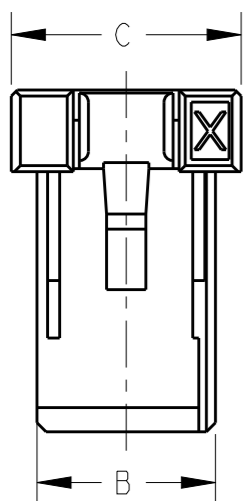
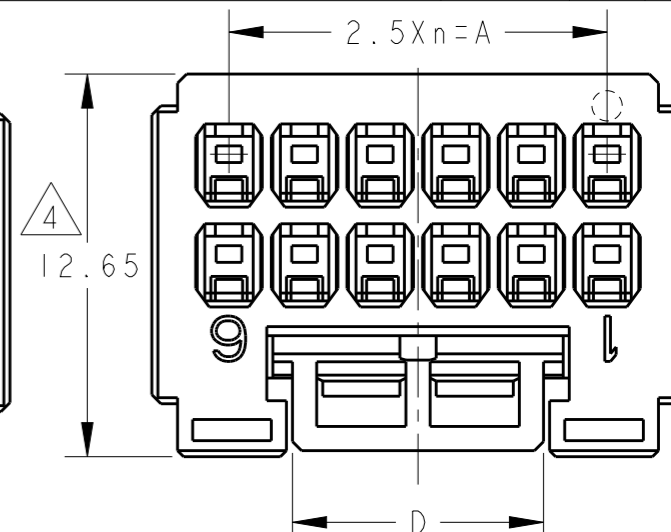
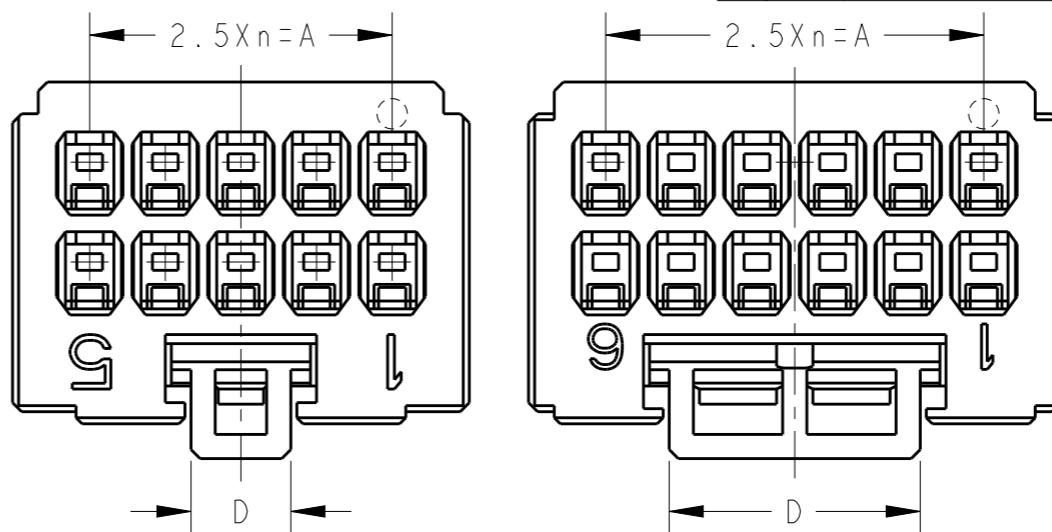
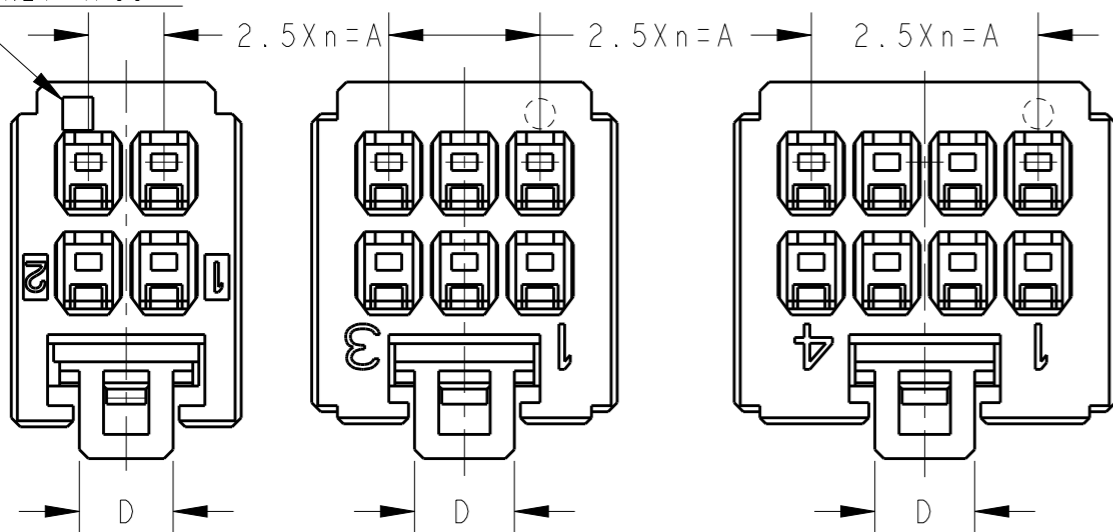

4POS(X-KEY)
1-1827864-2

6POS(X-KEY)
1-1827864-3

8POS(X-KEY)
1-1827864-4

10POS(X-KEY): 1-1827864-5 12POS(X-KEY): 1-1827864-6

4 12POS(X-KEY): 9-1827864-6

THIS DRAWING IS A CONTROLLED DOCUMENT.

DIMENSIONS:
單位: 毫
mm

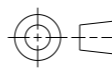

TOLERANCES UNLESS OTHERWISE SPECIFIED:

- 一般公差
- 0 PLC ±
- 1 PLC ±
- 2 PLC ±
- 3 PLC ±
- 4 PLC ±
- ANGLES ±
- FINISH 仕上

MATERIAL 材料

DWN T. KUDO 23AUG2005

CHK D. MITSUGI 23AUG2005

APVD D. MITSUGI 23AUG2005

PRODUCT SPEC 製品規格

108-78268, 78298

APPLICATION SPEC 取付適用規格

114-5377

WEIGHT

CUSTOMER DRAWING

NAME 名称

DYNAMIC DI200D 2.5mm PITCH
REC HSG
4-20 POS

SIZE

CAGE CODE

DRAWING NO 番号

RESTRICTED TO

A3

00779

C-1827864

SCALE 尺度

4:1

SHEET

2

OF

4

REV

E



TE Connectivity

THIS DRAWING IS UNPUBLISHED. RELEASED FOR PUBLICATION
 © COPYRIGHT - ALL RIGHTS RESERVED.

LOC	DIST	REVISIONS					
J		P	LTR	DESCRIPTION	DATE	DWN	APVD
		-		SEE SHEET 1	-	-	-

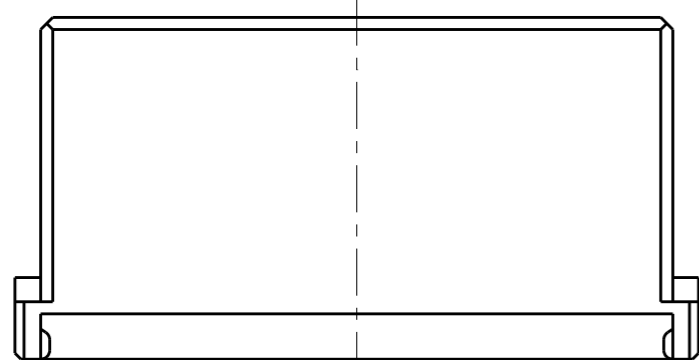
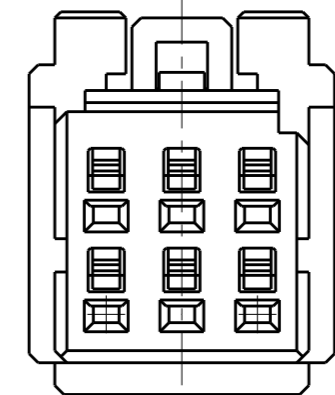
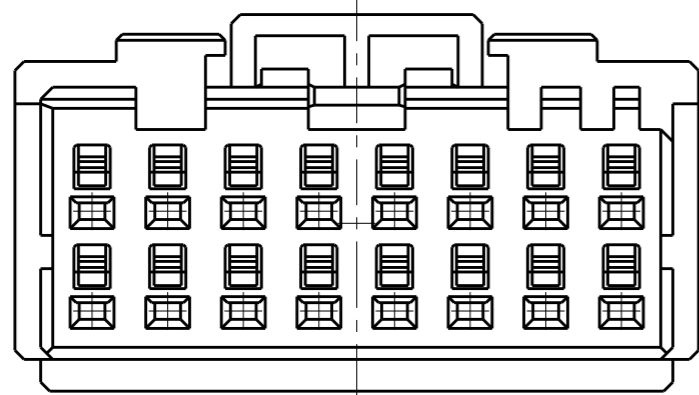
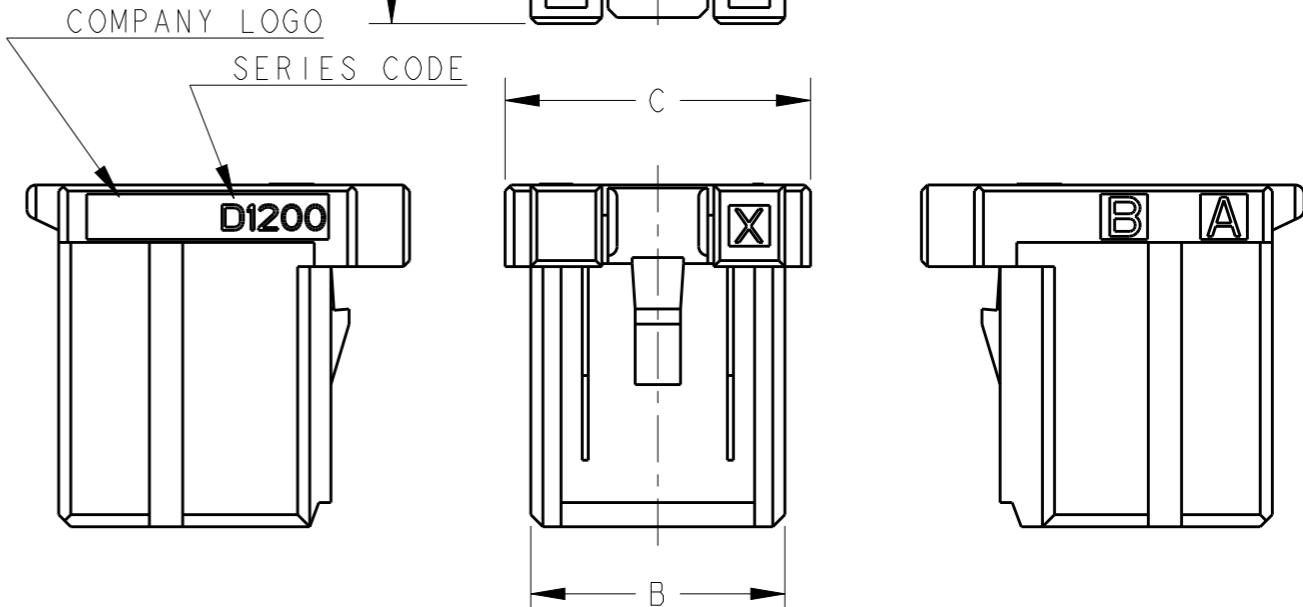
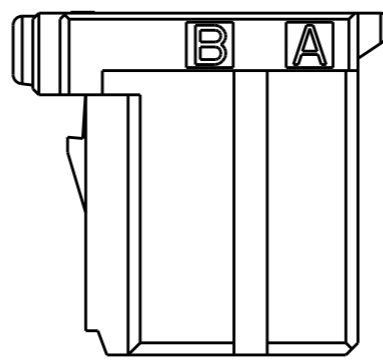
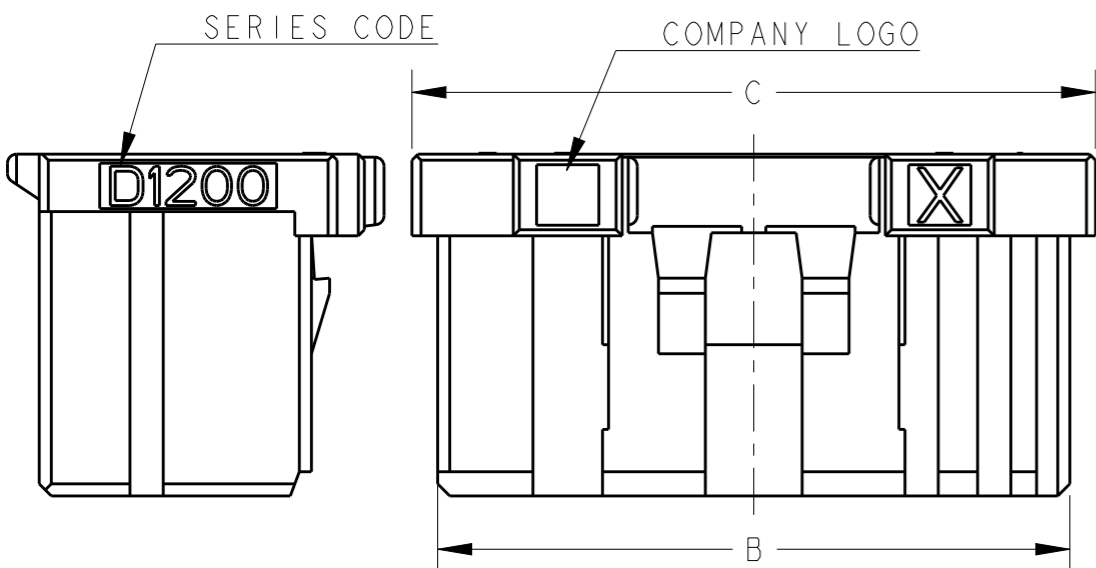
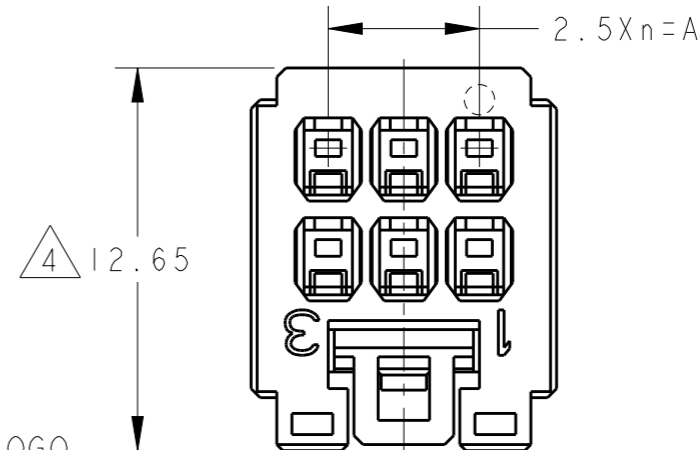
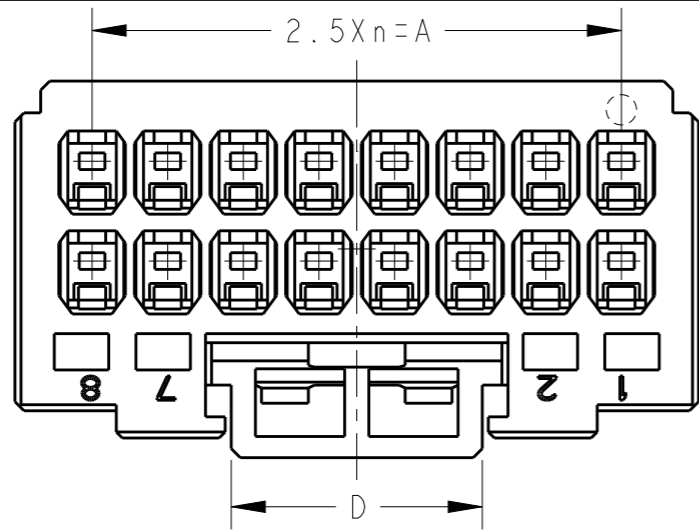

16POS(X-KEY): 1-1827864-8

6POS(X-KEY): 9-1827864-3

THIS DRAWING IS A CONTROLLED DOCUMENT.		DWN T. KUDO 23AUG2005	 TE Connectivity	
DIMENSIONS: 単位: 概 mm		CHK D. MITSUGI 23AUG2005		
TOLERANCES UNLESS OTHERWISE SPECIFIED: 一般公差		APVD D. MITSUGI 23AUG2005	NAME 名称 DYNAMIC DI200D 2.5mm PITCH	
0 PLC ±		PRODUCT SPEC 製品規格 108-78268, 78298	REC HSG	
1 PLC ±		APPLICATION SPEC 取付適用規格 114-5377	4-20 POS	
2 PLC ±		WEIGHT	SIZE A3	CAGE CODE 00779
3 PLC ±		CUSTOMER DRAWING	DRAWING NO 番号 C-1827864	RESTRICTED TO
4 PLC ±			SCALE 尺度 4:1	SHEET 3 OF 4
ANGLES ±				
FINISH 仕上				

THIS DRAWING IS UNPUBLISHED.

RELEASED FOR PUBLICATION

© COPYRIGHT -

ALL RIGHTS RESERVED.

LOC
J

DIST

REVISIONS
変更

P

LTR

DESCRIPTION

DATE

DWN

APVD

SEE SHEET 1

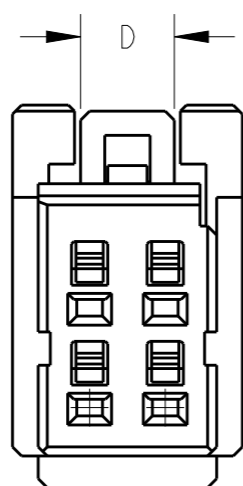
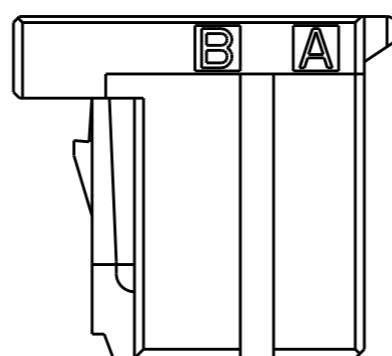
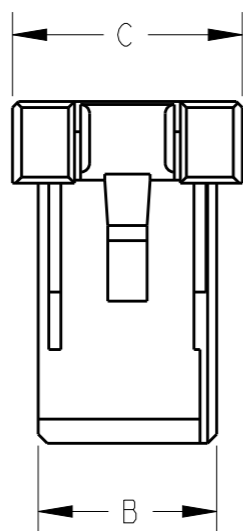
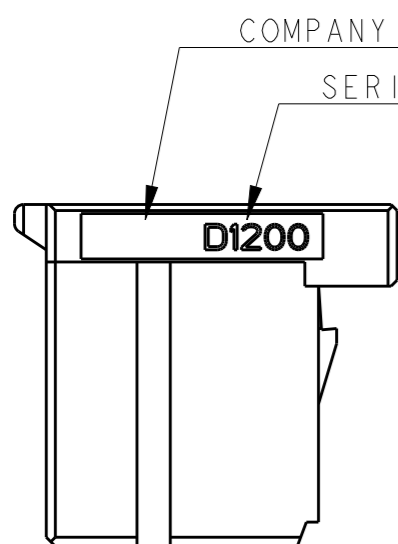
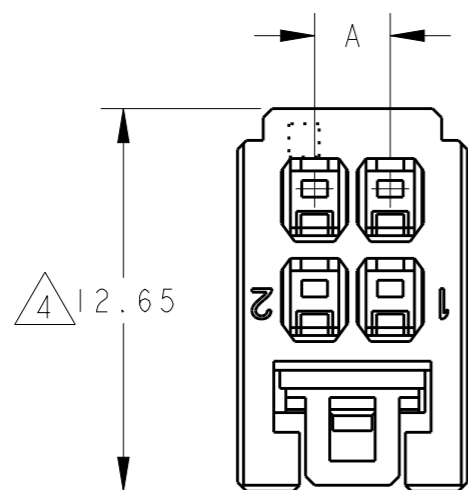

△ 4 POS(X-KEY): 9-1827864-2

THIS DRAWING IS A CONTROLLED DOCUMENT.

DIMENSIONS:
単位: 耗
mm

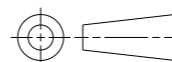

TOLERANCES UNLESS OTHERWISE SPECIFIED:

- 一般公差
- 0 PLC ±
- 1 PLC ±
- 2 PLC ±
- 3 PLC ±
- 4 PLC ±
- ANGLES ±

MATERIAL
材料

FINISH
仕上

DWN 23AUG2005

T. KUDO

CHK 23AUG2005

D. MITSUGI

APVD 23AUG2005

D. MITSUGI

PRODUCT SPEC

製品規格
108-78268, 78298

APPLICATION SPEC

取付適用規格
114-5377

WEIGHT

CUSTOMER DRAWING



TE Connectivity

NAME
名称

DYNAMIC D1200D 2.5mm PITCH
REC HSG
4-20 POS

SIZE

CAGE CODE

DRAWING NO
番号

RESTRICTED TO

A300779

C-1827864

SCALE
尺度 4:1

SHEET 4 OF 4

REV E